

















Międzynarodowy katalog opakowań

Niniejszy katalog został opracowany przez FEFCO i ESBO jako oficjalny system, mający zastąpić długie i skomplikowane opisy konstrukcji opakowań z tektury prostymi symbolami powszechnie rozumianymi w skali międzynarodowej, niezależnie od różnic językowych.

Odesłania mogą być stosowane w zamówieniach i specyfikacjach dotyczących opakowań. Zmian i uzupełnień mogą dokonywać jedynie FEFCO i ASSCO.

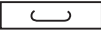
Symboly używane na rysunkach i w systemach komputerowych

Symbol	Kod komputerowy	Opis
Linie cięcia, bigowania		
	CL	Linia cięcia wykrojów opakowań
	S.C.	Wycięte szczeliny
	CI	Linie bigowania (zagięcia do wewnątrz)
	CO	Linie bigowania (zagięcia na zewnątrz)
	SI	Linie nacięć (zagięcie do wewnątrz)
	SO	Linie nacięć (zgięcie na zewnątrz)
	DS	Podwójne linie bigowania
	PL	Perforacja
	SE	Nóż falowany
	TP	Perforacja do zrywania (jodełka)
Sposoby łączenia opakowań		
	SJ	Połączenie przez zszywanie drutem
	TJ	Połączenie taśmą klejącą
	GJ	Połączenie przez sklejenie
Uchwyty		
	PC	Uchwyt wycięty (otwór)
	UC	Uchwyt niewycięty (z bigiem)
	NC	Uchwyt niewycięty (z bigiem)
Kierunek fali		
	FD	Oznaczenie kierunku fali

Wykroje opakowań w niniejszym katalogu postrzegane są od strony wewnętrznej

Wymiary pudeł

O ile nie wskazano inaczej, wszystkie wymiary wyrażono jako wymiary wewnętrzne w mm, jak następuje:

Długość (L) x Szerokość (B) x Wysokość (H).
Długość (L) = dłuższy z wymiarów w ustawieniu do otwarcia opakowania.

Szerokość (B) = krótszy z wymiarów w ustawieniu do otwarcia opakowania.

Wysokość (H) = wymiar pomiędzy podstawą a górą opakowania.

Wymiary L, B, H podaje się w każdym opisie konstrukcji pułta, przy czym w przypadku niektórych modeli wartość liczbową B może przekraczać wartość liczbową L.

Wymiary należy ustalać w standardowych warunkach klimatycznych, na rozłożonym wykroju od środka bigu, uwzględniając grubość materiału.

W przypadku pudeł teleskopowych wysokość (h) górnej części (pokrywy) powinna być podawana jako czwarty wymiar, po ukośniku, np.:

355 x 205 x 120/40 mm
(L) (B) (H) (h)

W przypadku pudeł z nachodzącymi na siebie klapami zewnętrznymi długość nachodzenia (o) powinna być podawana jako czwarty wymiar, po ukośniku, np.:

355 x 205 x 120/40 mm
(L) (B) (H) (o)

Wymiary arkuszy

O ile nie podano inaczej, wymiary arkuszy tektury falistej podaje się w mm, jak następuje:

1 wymiar x 2 wymiar

1 wymiar = wzdłuż kierunku fali

2 wymiar = w poprzek kierunku fali

Wersje standardów

Dla kilku typów pudeł istnieją wersje pochodne, bez potrzeby tworzenia nowego standardu. W takich przypadkach należy dodawać rozszerzenie do podstawowego numeru standardu, oddzielając go myślnikiem.

Przykład: 0201-2

Wersja taka może u danego producenta mieć charakter indywidualny.

Łączenie standardów

Przedstawione standardy konstrukcji stanowią podstawowe typy pudeł z tektury. Jeśli konstrukcja ostateczna jest kombinacją dwóch lub trzech modeli podstawowych, np. z zastosowaniem klap, może ona także zostać opisana jak następuje:

Klapy góry jak w 0204, klapy spodu jak w 0215

Typ ten może również zostać opisany jako 0204/0215 (klapy góry, klapy spodu).

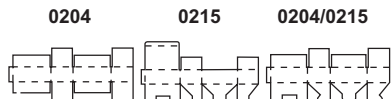

Rodzaje łączenia pudeł

Układy pokazane na rysunkach w niniejszym katalogu mogą być zmieniane stosownie do wybranego przez producenta łączenia. W niektórych konstrukcjach połączenia te mogą polegać na klejeniu, stosowaniu taśmy klejącej albo szyciu. Klapka przeznaczona do klejenia lub szycia może być przy dłuższym lub krótszym boku. Poniższe szkice demonstrują, w jaki sposób połączenia takie mogą zostać wskazane na rysunku:

Przykład dotyczący wszystkich konstrukcji:

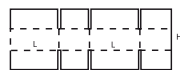
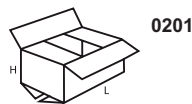

Połączenie taśmą klejącą

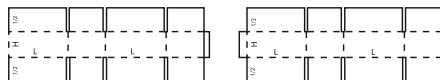

Połączenie klejone albo szyte

Dotyczy to wszystkich wzorów objętych niniejszym katalogiem.

Składanie ręczne lub automatyczne

Każda konstrukcja opakowania ma jedną z następujących cech:

M - zwykle składanie ręczne

A - zwykle składanie automatyczne

M/A - oznacza, że składanie ma charakter ręczny lub automatyczny, M+A wymaga połączenia obydwu rodzajów.

Wskazania te oparte są na aktualnej praktyce, a ich celem jest przekazanie dodatkowej informacji tym, którzy tworzą specyfikacje oraz użytkownikom. Niektóre z ręcznie składanych pudeł mogą być zamykane automatycznie (np.: 0216 albo 0712).

Opis podstawowych rodzajów konstrukcji*

*Określenia pudło ,pojemnik i skrzynka mają ,w kontekście tych opisów ,charakter zamienny .

Należy zwrócić uwagę , że kilka wzorów zawartych w katalogu pod danym numerem może zostać również sklasyfikowanych w ramach innych podstawowych typów grup.

01 – Rolki i arkusze stosowane w handlu

02 – Pudła klapowe

Pudła klapowe są to pudła złożone zasadniczo z jednej części, których brzeg jest klejony, szyty, albo które mają połączenie taśmą klejącą oraz posiadają górne i dolne klapy. Producent wysyła je złożone na płask, gotowe do użycia, a zamyka przy zastosowaniu klap.

03 - Pudła teleskopowe

Pudła teleskopowe składają się z więcej niż jednej części i charakteryzuje je istnienie wieka i/lub spodu, które zachodzą teleskopowo na siebie.

04 - Pudła składane i tace

Pudła składane i tace, zwykle składają się tylko z jednego formatu. Dno pudła składa się tak, by utworzyć dwie lub więcej ścian bocznych oraz pokrywę. W niektórych wzorach mogą się pojawiać zamknięcia, uchwyty, okienka itd.

05 - Pudła wsuwane

Pudła te składają się z większej ilości części (wewnętrznych oraz obwolut), które można w różnych kierunkach wsuwać jedno w drugie. Grupa ta obejmuje także obwoluty dla innych pudeł.

06 - Pudła trwale łączone

Pudła trwale łączone składają się z dwóch oddzielnych części końcowych oraz korpusu i wymagają, przed ich użyciem, szycia albo podobnej operacji.

07 - Pudła klejone jednoczęściowe

Są to pudła klejone, złożone zwykle z jednej części, dostarczane w stanie złożonym i gotowe do użycia po ich prostym rozłożeniu.

09 - Wyposażenie wewnętrzne

Wyposażenie wewnętrzne pudeł, takie jak wkładki, przekładki, kratownice, wkładki wypełniające itd., stanowiące elementy związane z konstrukcją pudła albo osobne. Wskazana ilość elementów jest dowolna i może być, stosownie od wymagań, zwiększana lub zmniejszana.

Kod pełny: XXXX - XXXX	
Standard	Wersja standardu
XXXX	- XXXX
Standardowy uznany kształt/wzór dla tego kodu	Numer wersji, służący odróżnieniu odchylenia od wzoru standardowego (odpowiadający indywidualnemu rysunkowi albo elementowi biblioteki CAD/CAM)

Zamknięcia pudeł

Właściwe i skuteczne zamknięcia opakowań są równie ważne jak sama konstrukcja opakowania.

Następujące rodzaje zamknięć możliwe są albo pojedynczo, albo w połączeniu z innymi:

- klejenie na zakładkę, na zimno lub gorąco
- klejenie taśmą klejącą
- zablokowanie
- szycie drutem.

Łączenie taśmą klejącą

Wykonuje się je stosownie do pokazanych niżej przykładów.

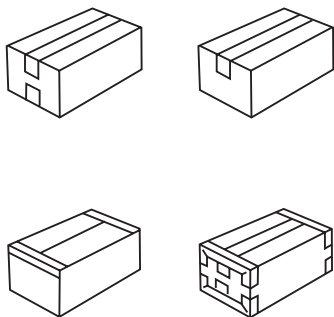

Szycie drutem

Wykonuje się je stosownie do pokazanych niżej przykładów.



Kodowanie wyposażenia

Następujący zakres elementów wyposażenia wewnętrznego podlega kodowaniu w zależności od liczby zastosowanych elementów, w dowolnej kombinacji kształtów (dla systemów komputerowych).

Liczba elementów		KOD
2	>	0982
3	>	0983
4	>	0984
5	>	0985
6	>	0986
7	>	0987
8	>	0988
9	>	0989
10	>	0990
11	>	0991
12	>	0992
13	>	0993
14>		0994
15	>	0995
16	>	0996
17	>	0997
18	>	0998
19	>	0999

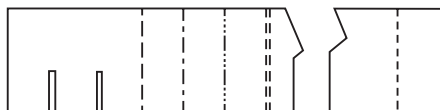

0982/0999
M

0100

- ▲ Rolki i arkusze stosowane w handlu
- ▲ Commercial rolls and sheets

0100

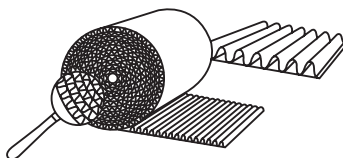

0110

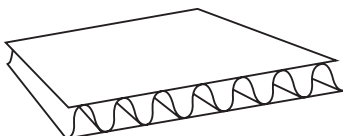

0200

- ▶ **Pudła klapowe** są to pudełka złożone zasadniczo z jednej części, których brzeg jest klejony, szyty, albo które mają połączenie taśmą klejącą oraz posiadają górne i dolne klapy. Producent wysyła je złożone na płask, gotowe do użycia, a zamyka przy zastosowaniu klap.

0200

M/A

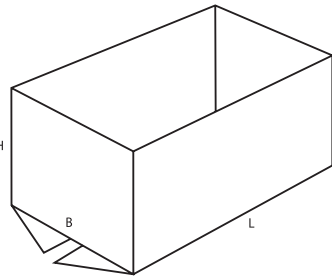

0201

M/A

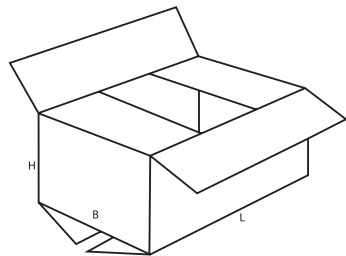
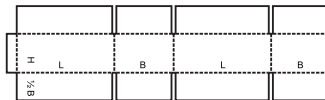

0202

M/A

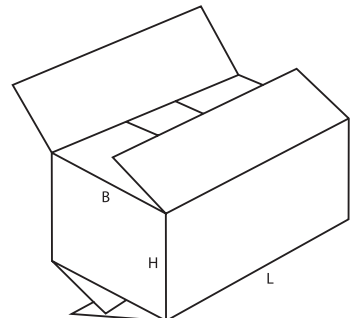
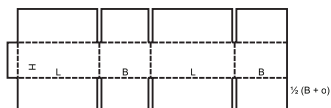

0203

M/A

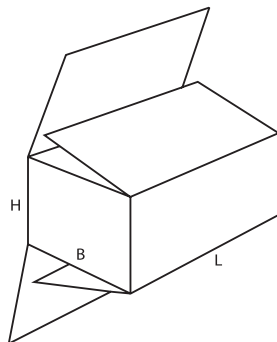
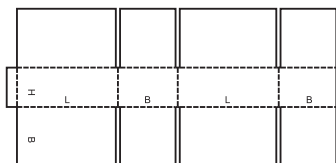

0204

M/A

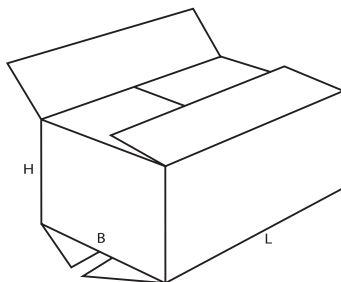
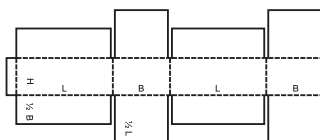

0205

M/A

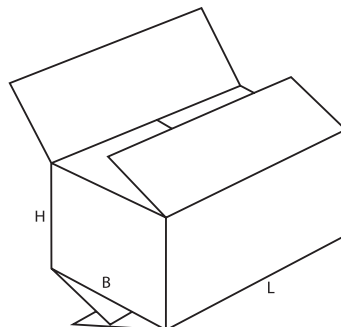
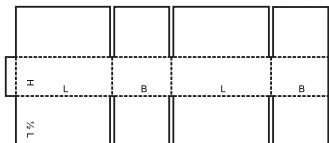

0206

M/A

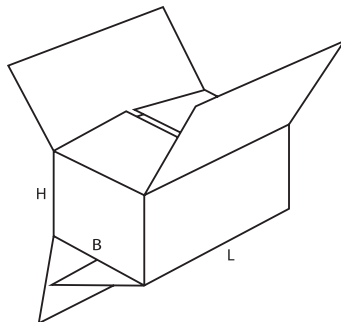
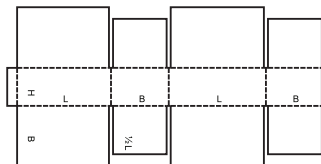

0207

M

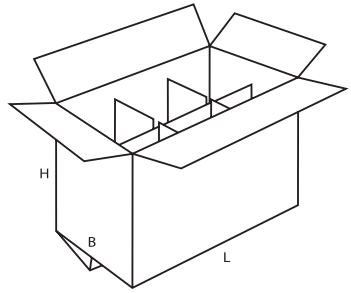
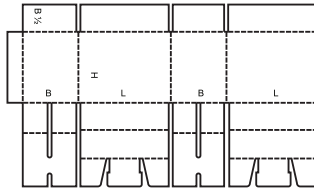

0208

M

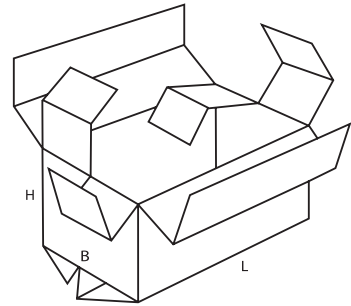
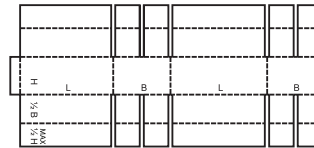

0209

M/A

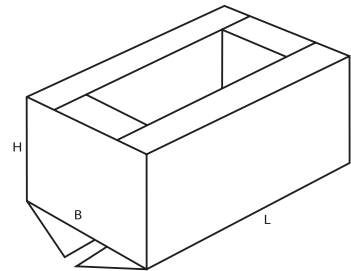
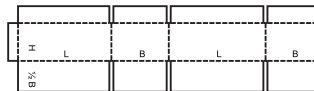

0210

M

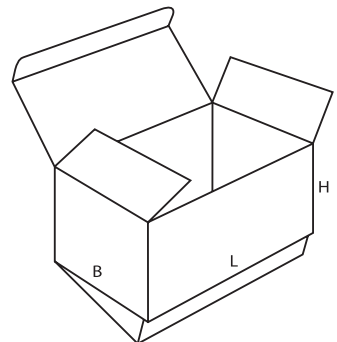
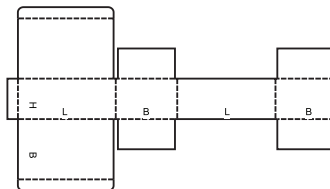

0211

M

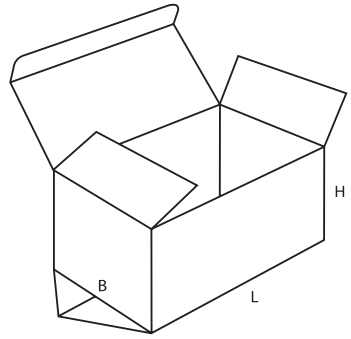
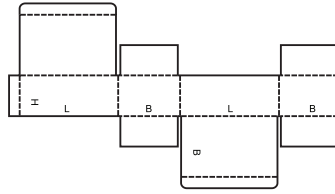

0212

M/A

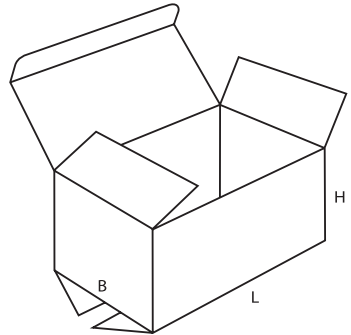
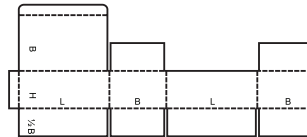

0214

M

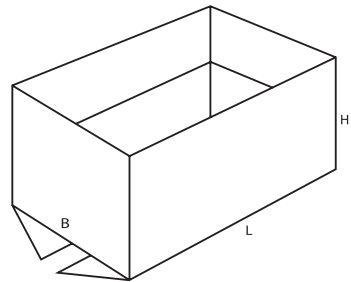
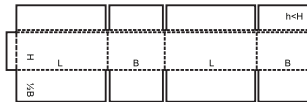

0215

M

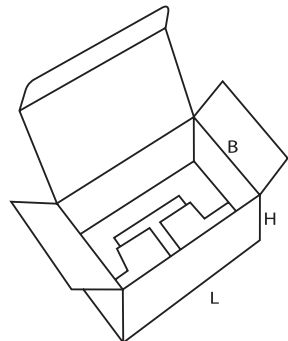
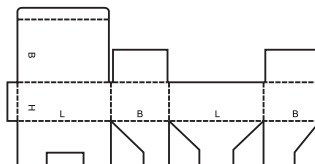

0216

M

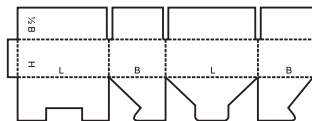

closure of top can be automated

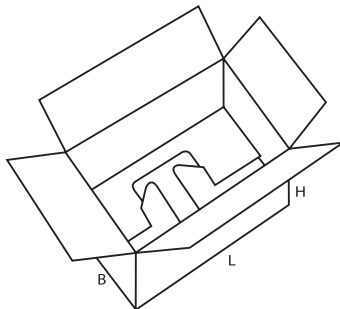

0217

M

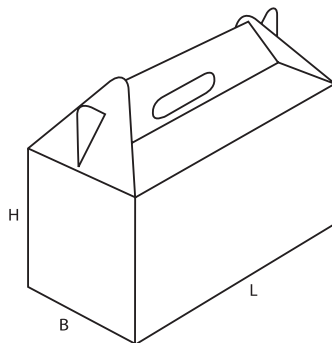
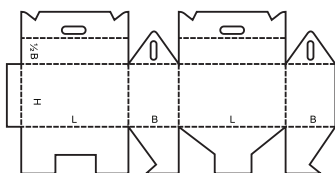

0218

M

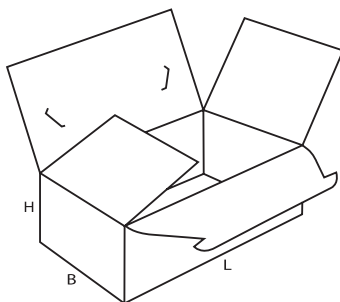
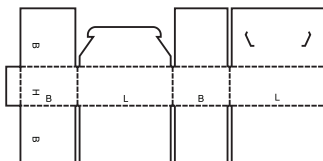

0225

M

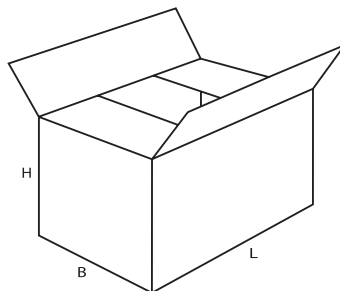
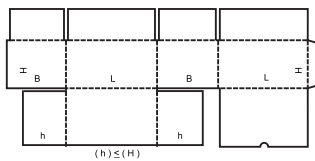

0226

M

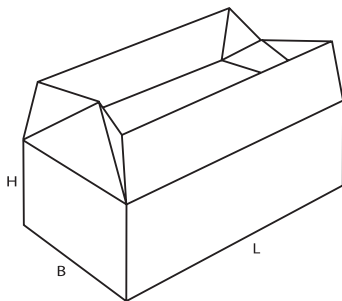
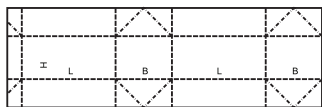

0227

M

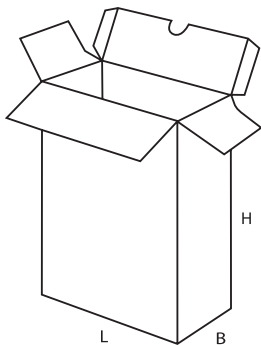
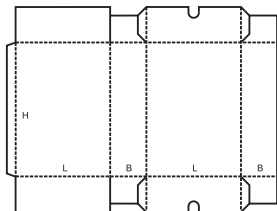

0228

M/A

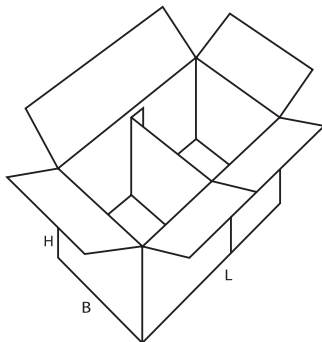
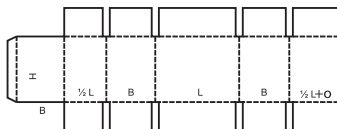

0229

M

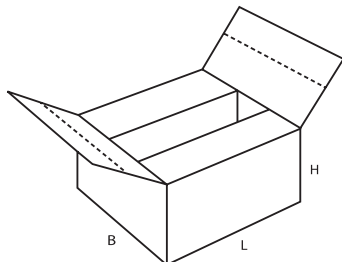
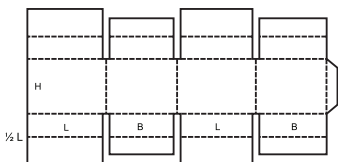

0230

M/A

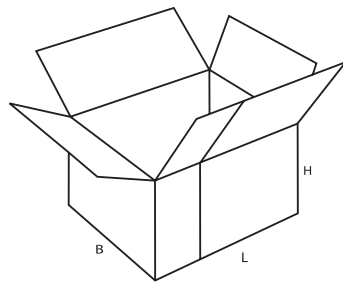
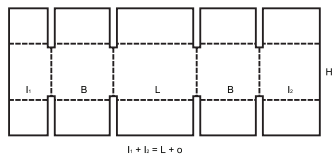

0231

M/A

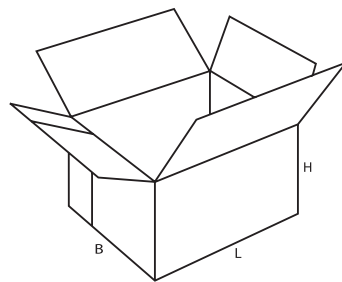
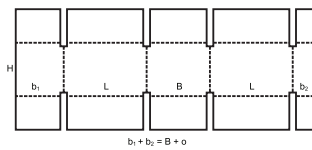

- ▲ **Podia teleskopowe** składają się z więcej niż jednej części i charakteryzuje je istnienie wieka i/lub spodu, które zachodzą teleskopowo na siebie.

0300

M/A

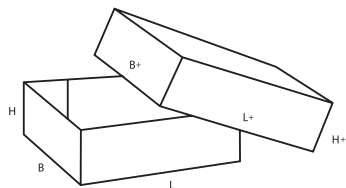
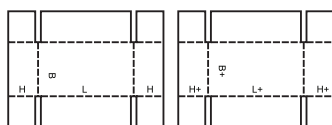

0301

M/A

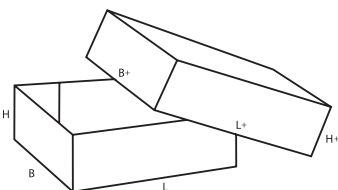
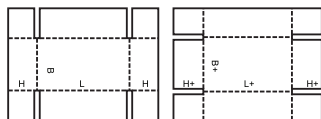

0302

M

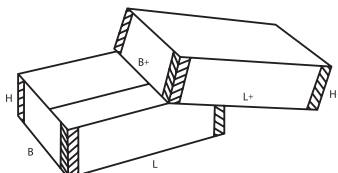
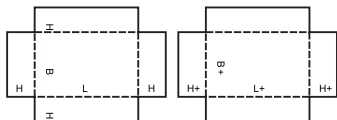

0303

M

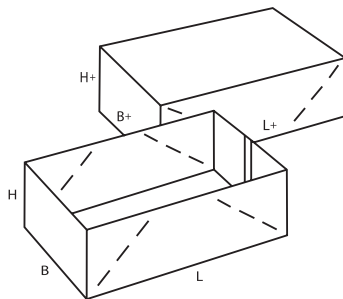
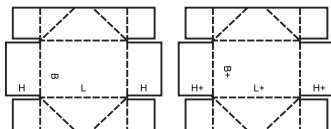

0304

M

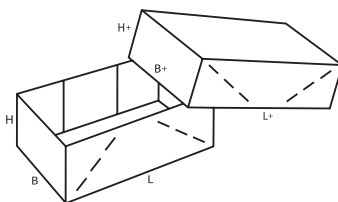
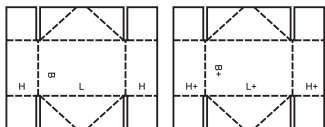

0306

M/A

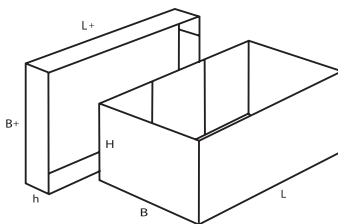
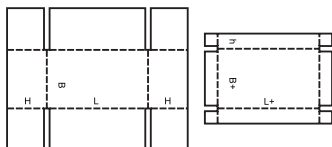

0307

M

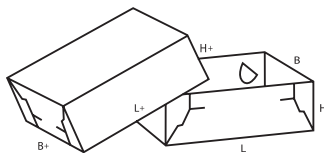
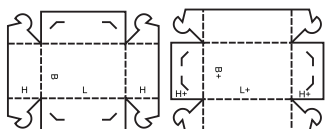

0308

M

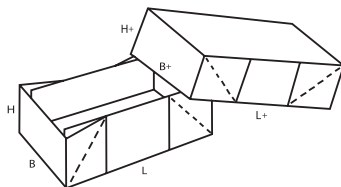
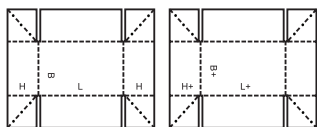

0309

M

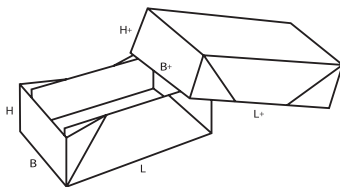
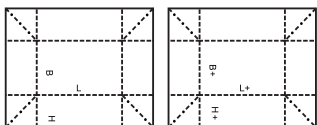

0310

M+A

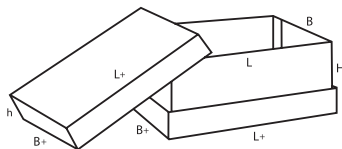
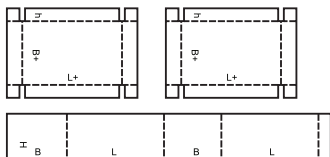

0312

M/A

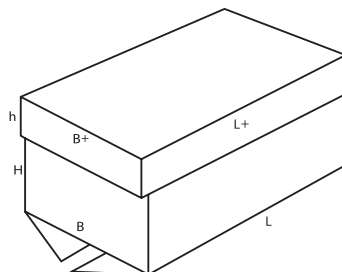
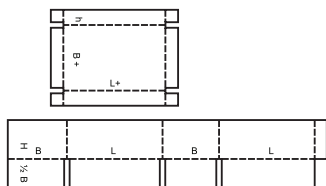

0313

M/A

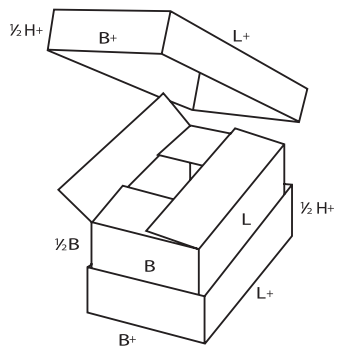
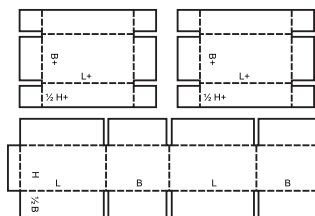

0314

M

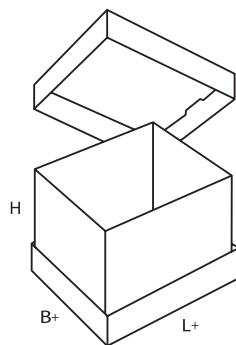
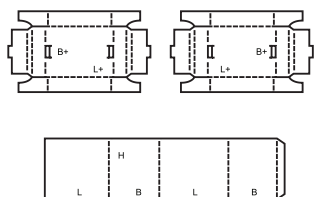

0320

M/A

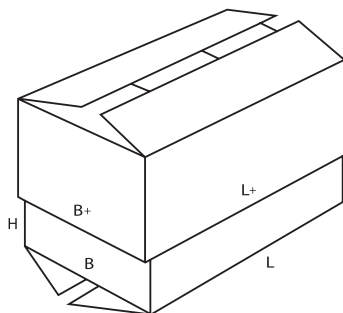
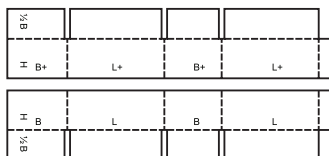

0321

M

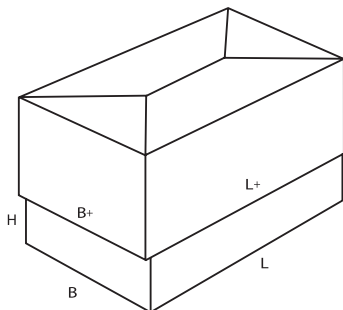
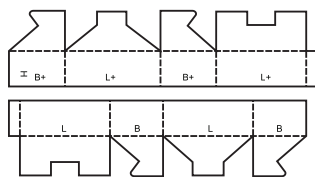

0322

M

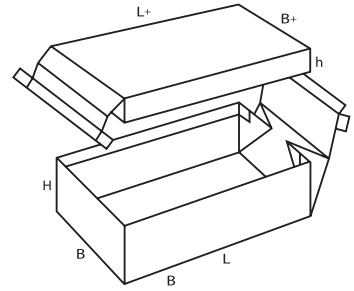
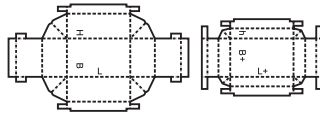

0323

M

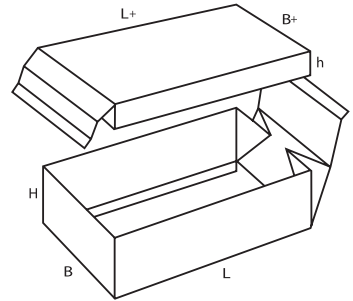
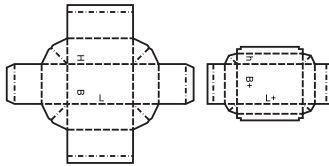

0325

A

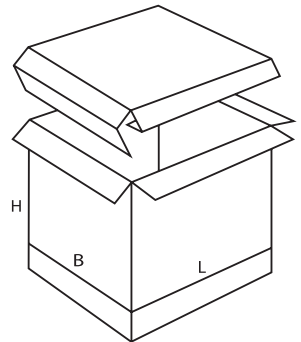
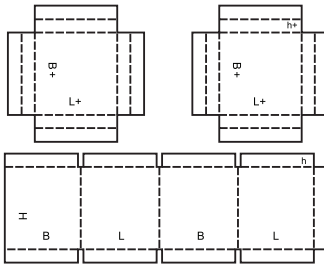

0330

M/A

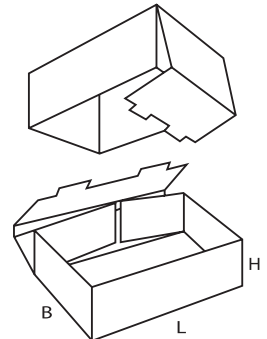
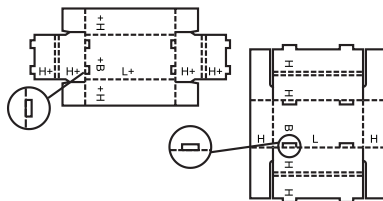

0331

M/A

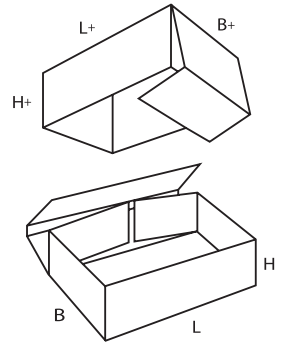
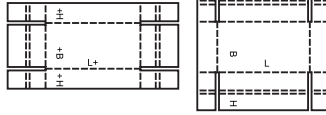

0350

M

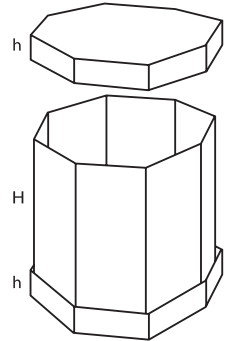
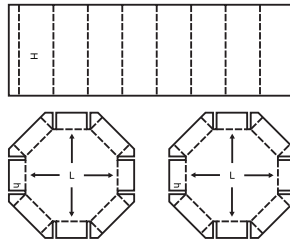

0351

M/A

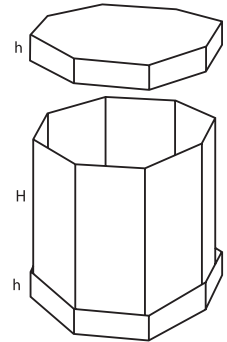
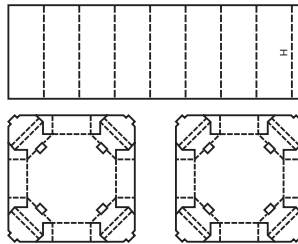

0352

M/A

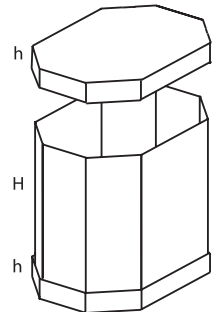
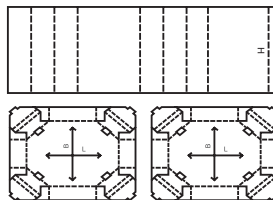

- Pudła składane i tace zwykle składają się tylko z jednego formatu. Dno pudła składa się tak, by utworzyć dwie lub więcej ścian bocznych oraz pokrywę. W niektórych wzorach mogą się pojawiać zamknięcia, uchwyty, okienka itd.

0400

M

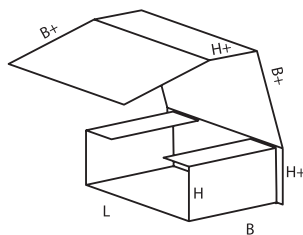
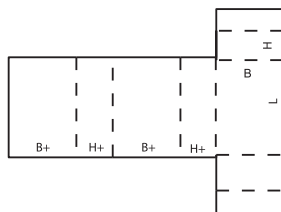

0401

M

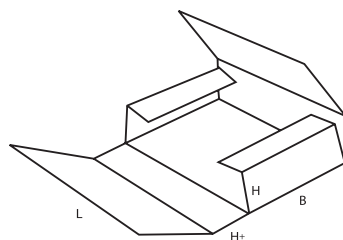
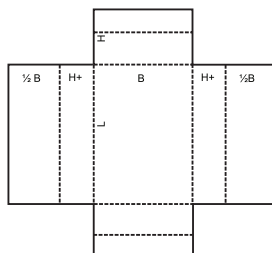

0402

M

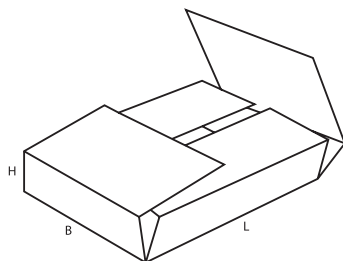
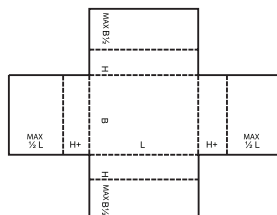

0403

M

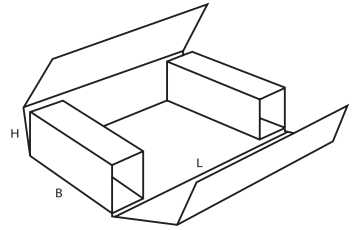
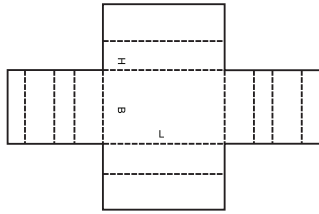

0404

M

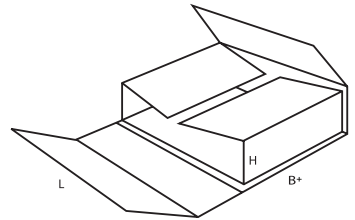
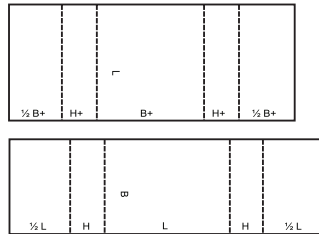

0405

M

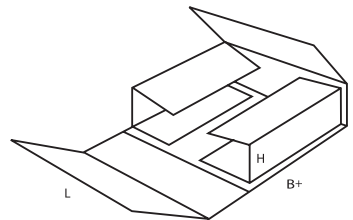
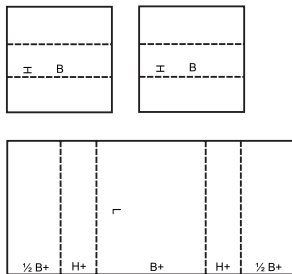

0406

A

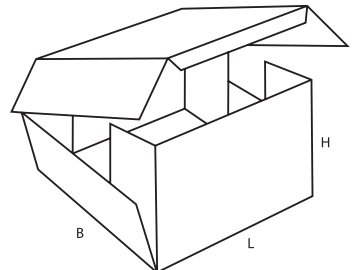
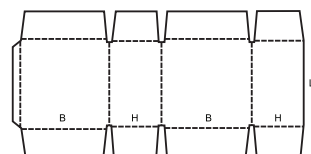

0409

M

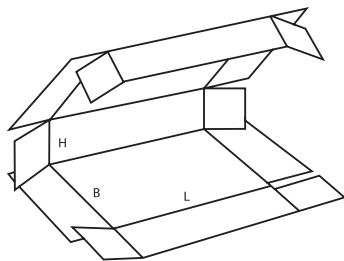
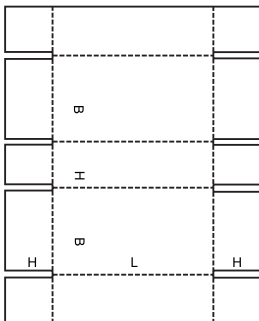

0410

M/A

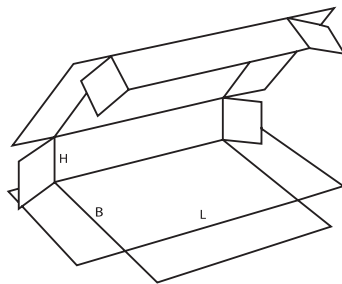
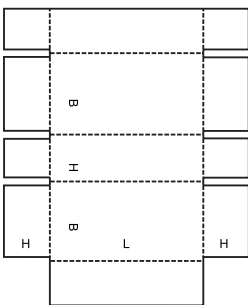

0411

M/A

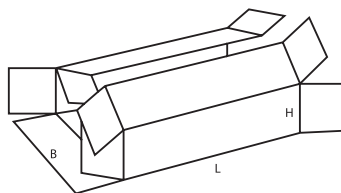
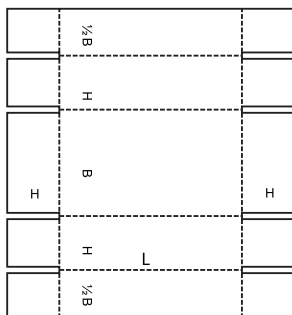

0412

M

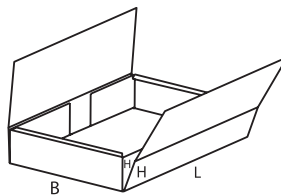
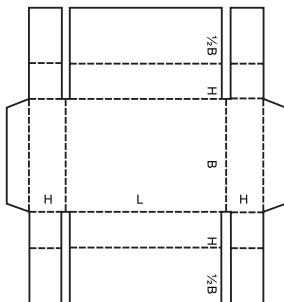

0413

M/A

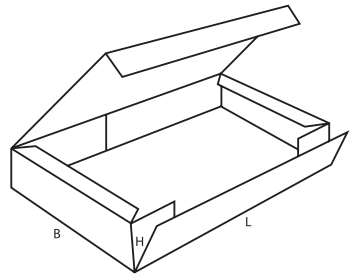
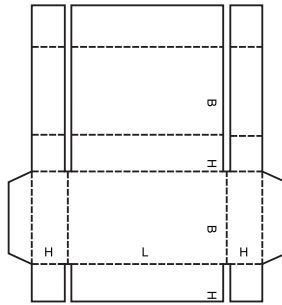

0415

M/A

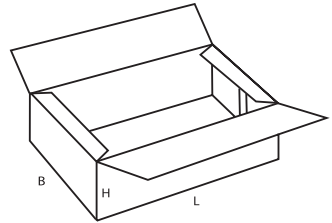
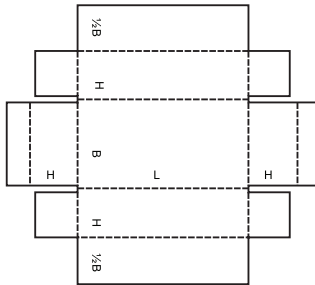

0416

M

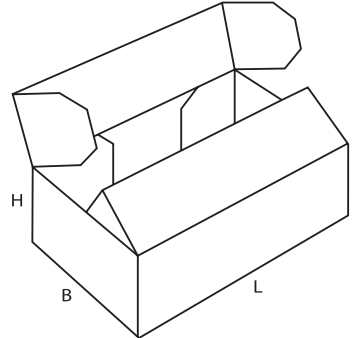
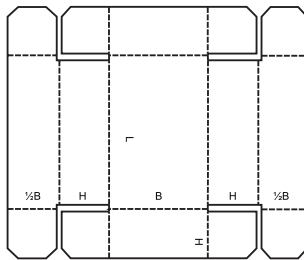

0420

M/A

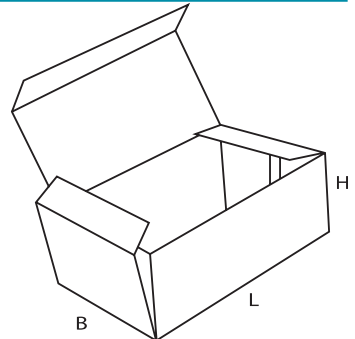
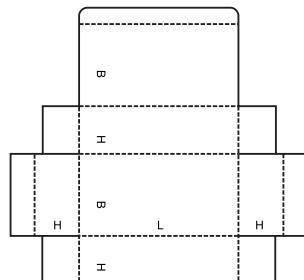

0421

M/A

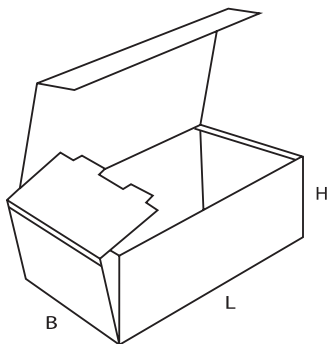
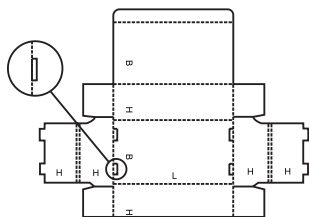

0422

M/A

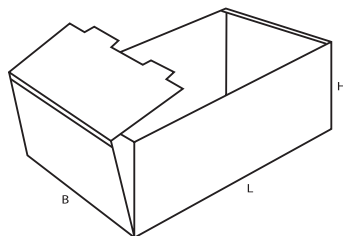
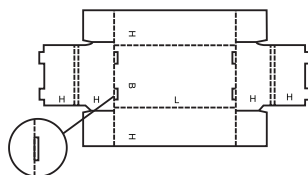

0423

M/A

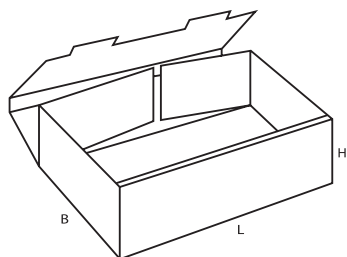
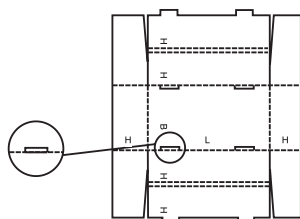

0424

M/A

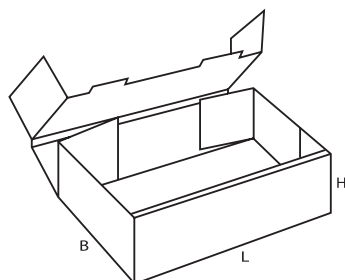
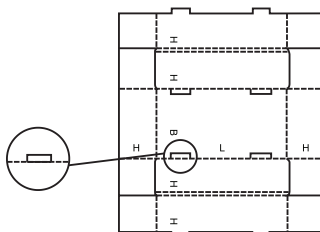

0425

M/A

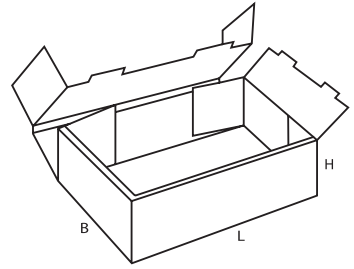
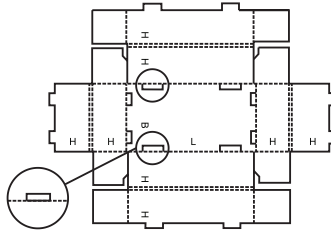

0426

M

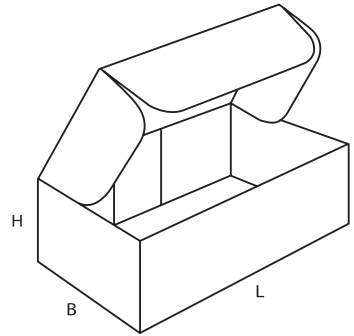
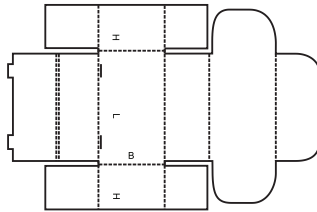

0427

M

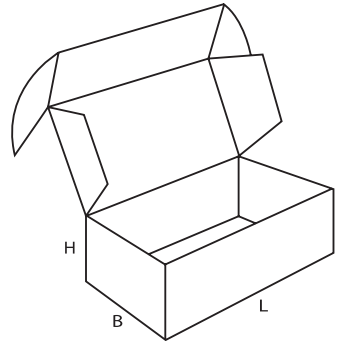
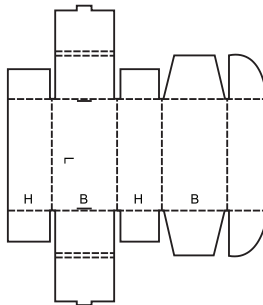

0428

M

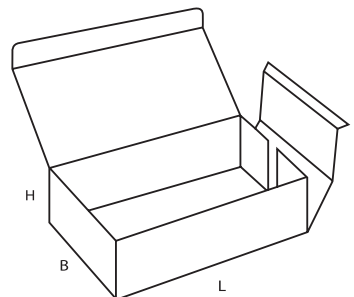
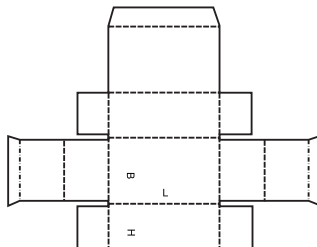

0429

M

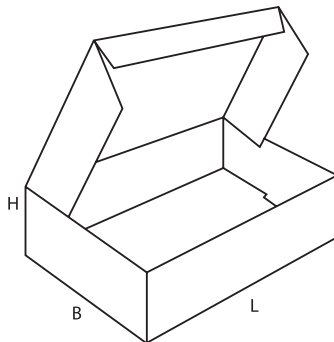
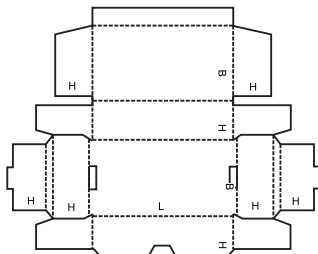

0430

M/A

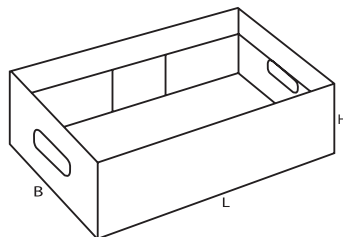
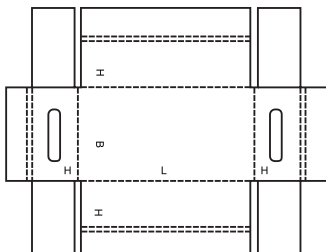

0431

M

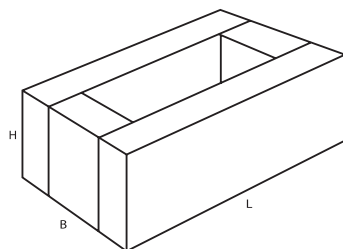
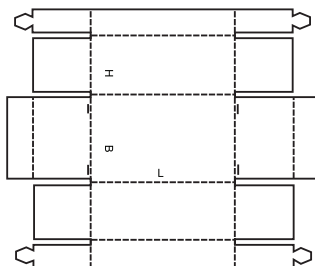

0432

M

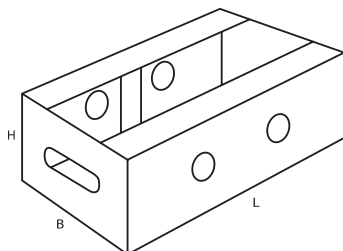
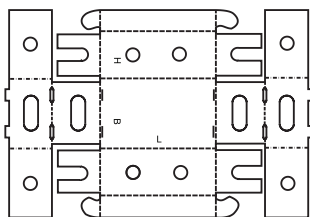

0433

M

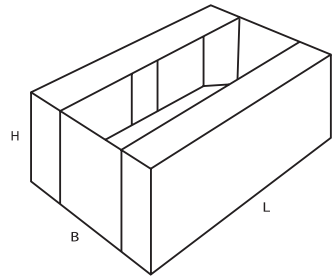
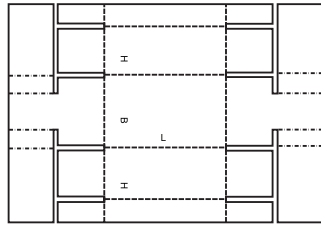

0434

M

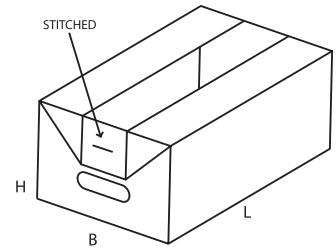
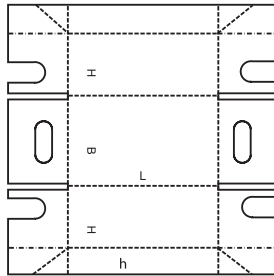

0435

M/A

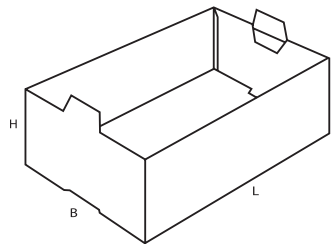
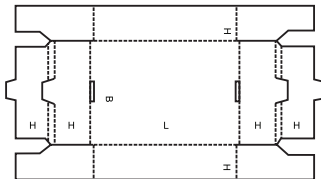

0436

M

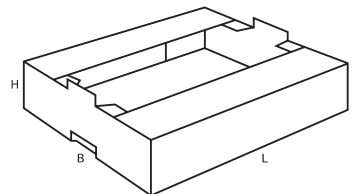
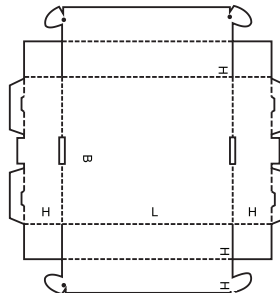

0437

M

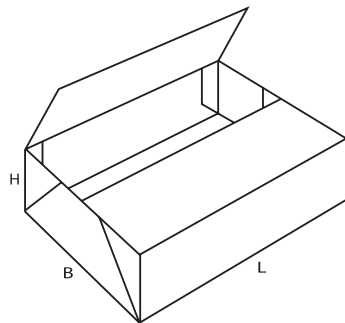
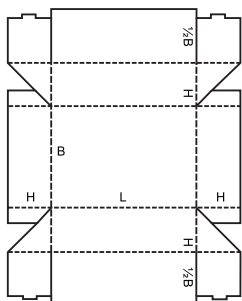

0440

A

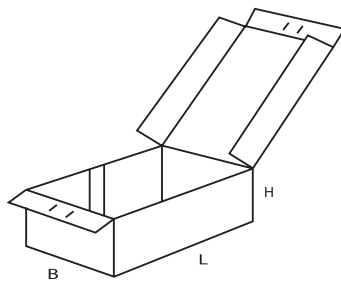
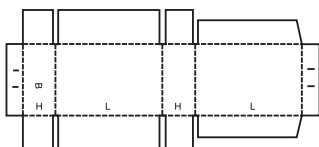

0441

A

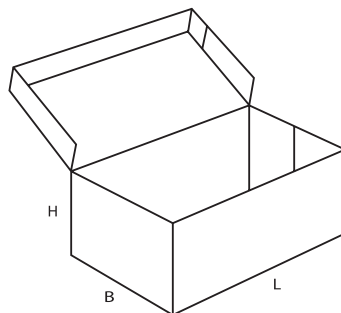
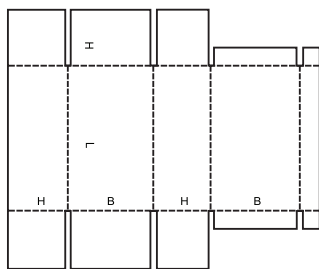

0442

M

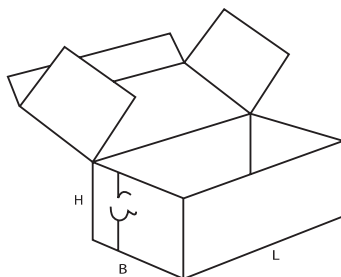
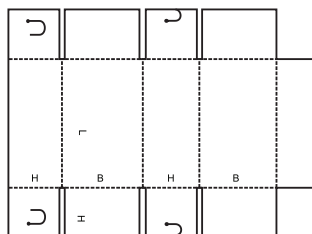

0443

M

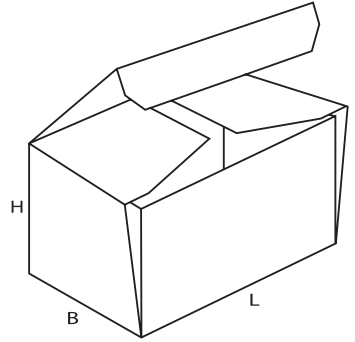
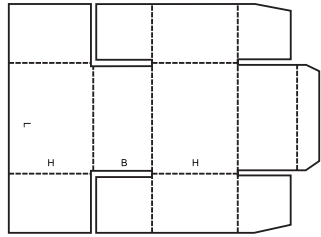

0444

M

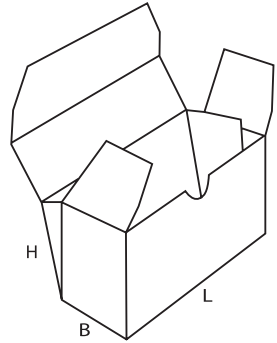
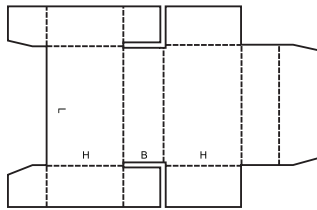

0445

M

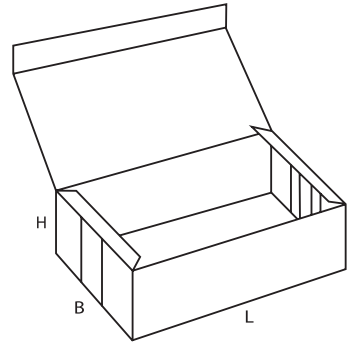
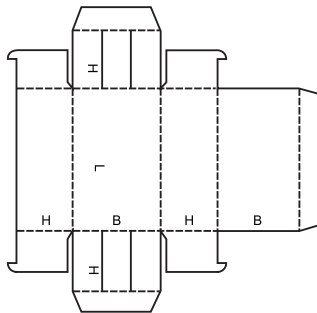

0446

A

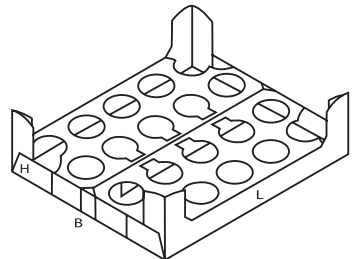
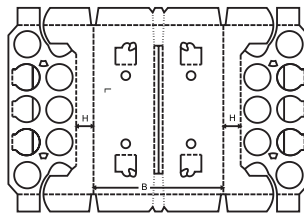

0447

M

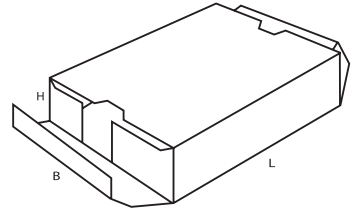
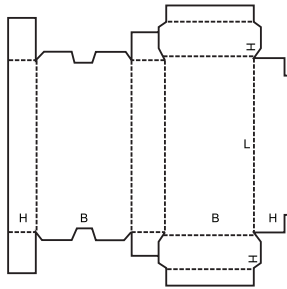

0448

M

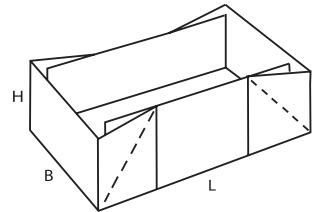
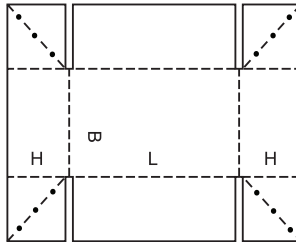

0449

M

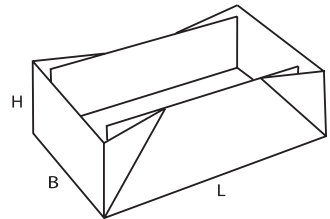
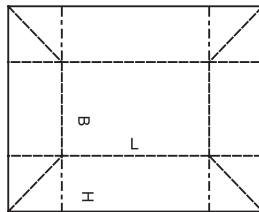

0450

M

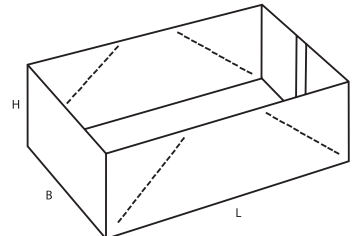
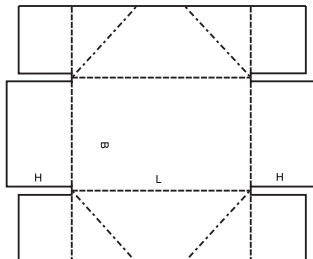

0451

M

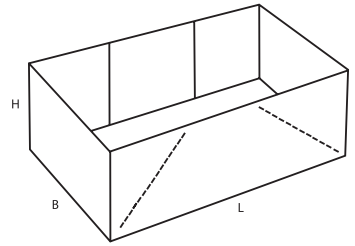
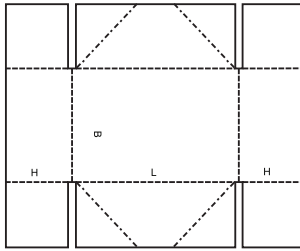

0452

A

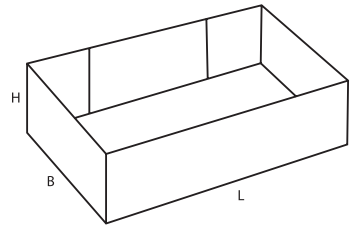
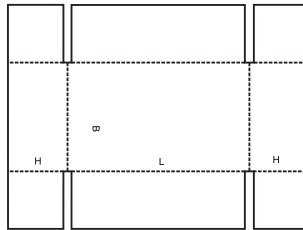

0453

A

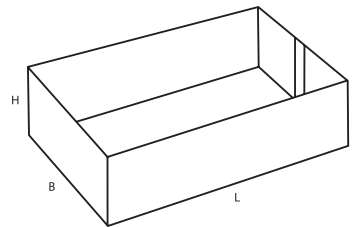
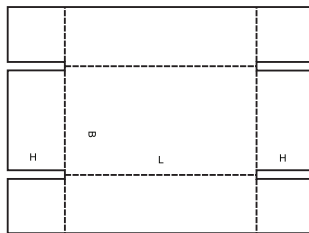

0454

M

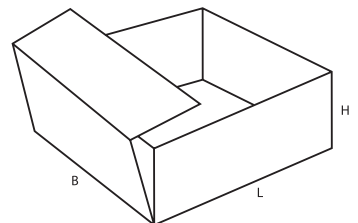
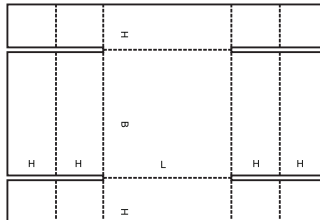

0455

M

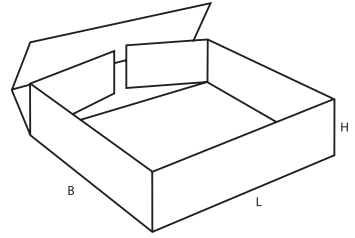
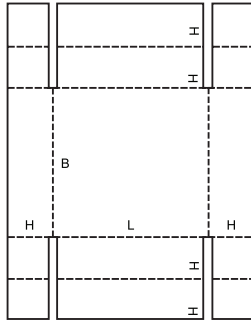

0456

M

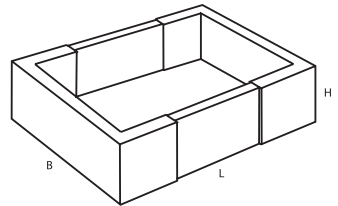
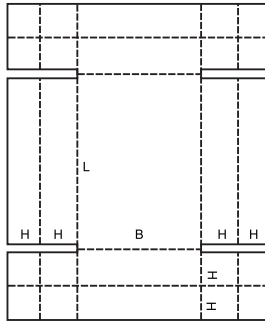

0457

M

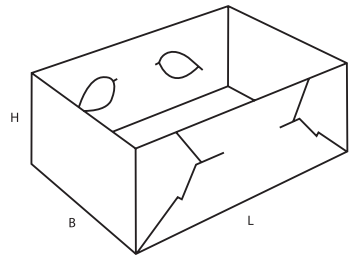
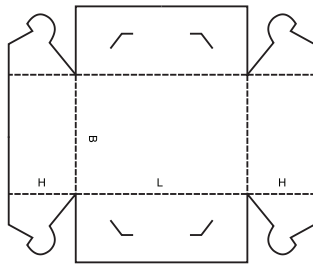

0458

M

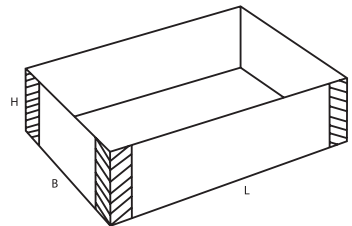
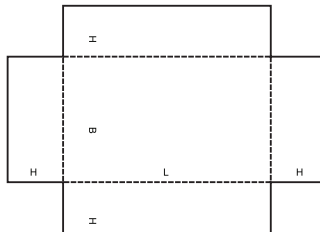

0459

A

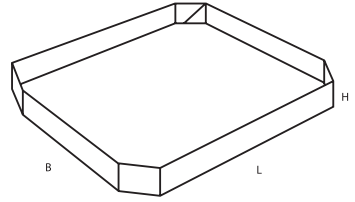
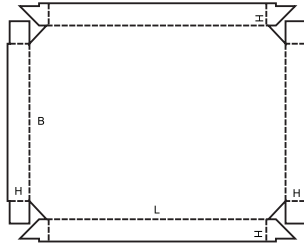

0460

A

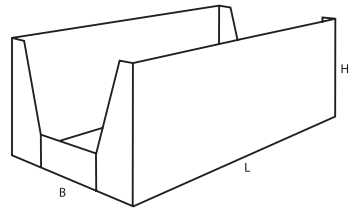
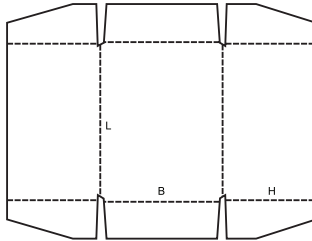

0470

M

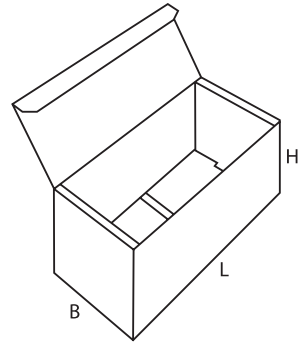
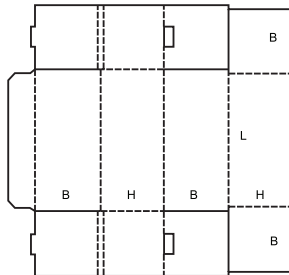

0471

M

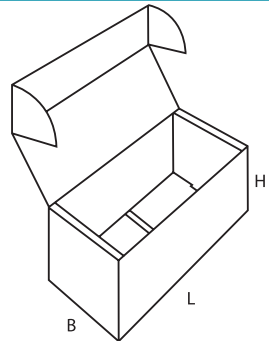
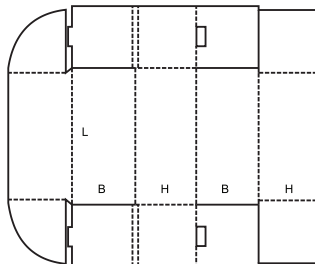

0472

M

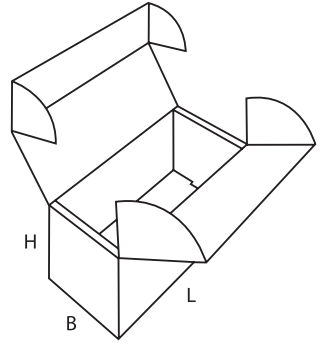
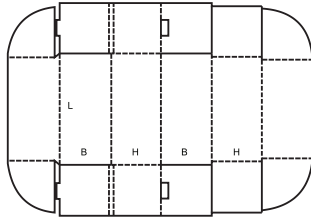

0473

M

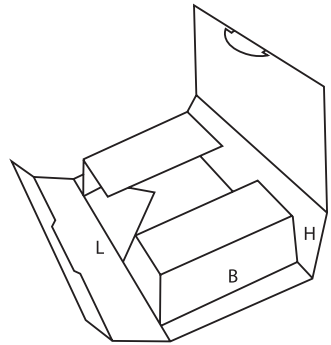
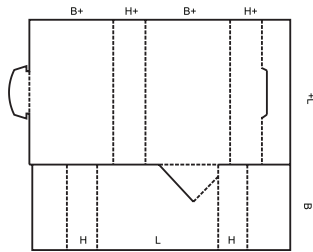

0500

- ▲ **Pudła wsuwane** składają się z większej ilości części (wewnętrznych oraz obwolut), które można w różnych kierunkach wsuwać jedno w drugie. Grupa ta obejmuje także obwoluty dla innych pudeł.

0501

M

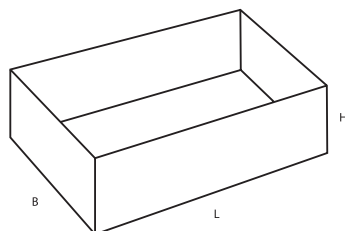
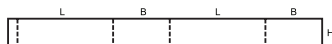

0502

M

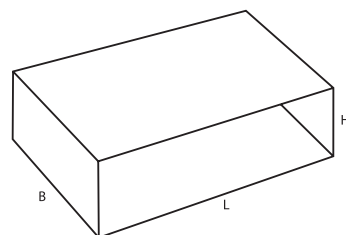
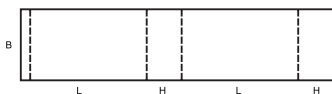

0503

M

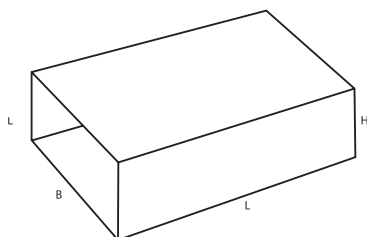
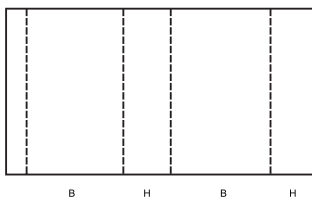

0504

M

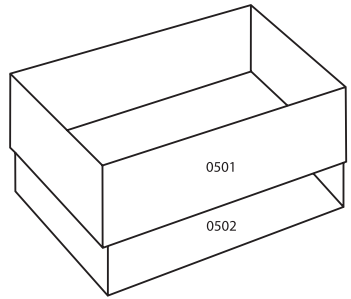
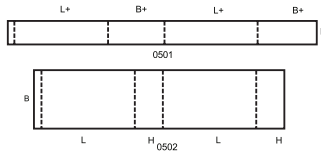

0505

M

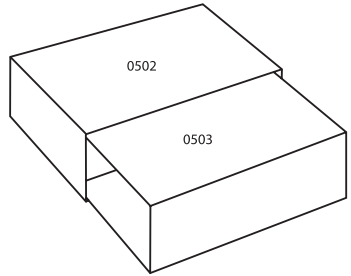
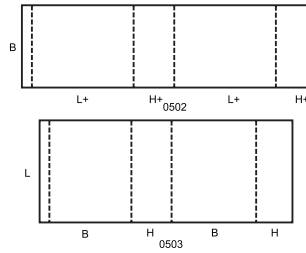

0507

M

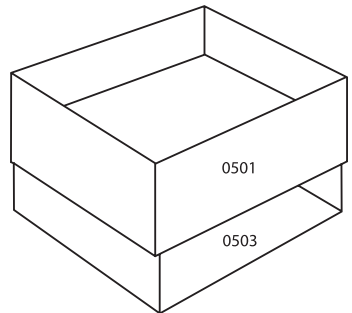
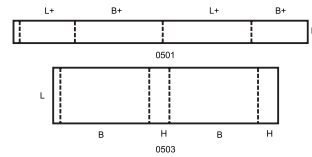

0509

M

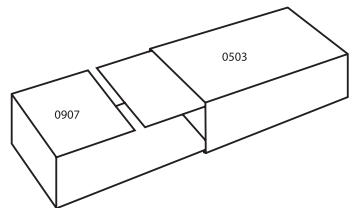
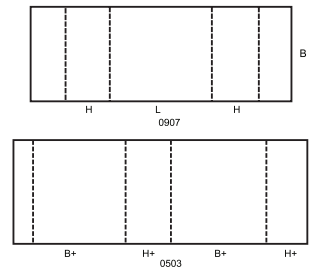

0510

M

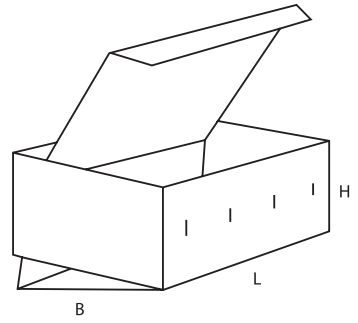
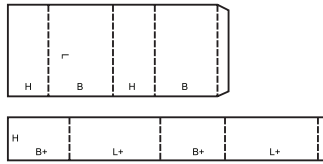

0511

M

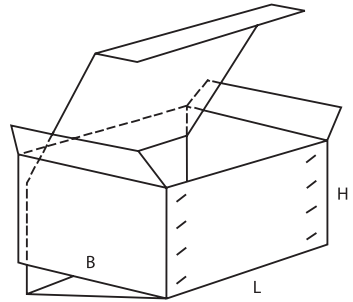
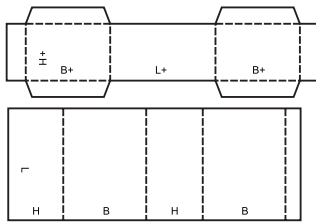

0512

M

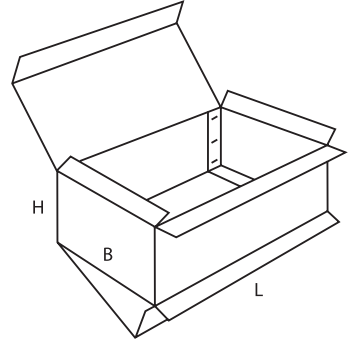
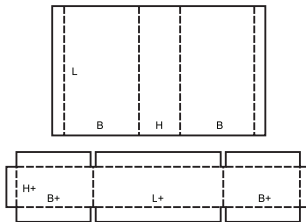

- Pudełka trwale łączone** składają się z dwóch oddzielnych części końcowych oraz korpusu i wymagają, przed ich użyciem, zszycia albo podobnej operacji.

0601

A

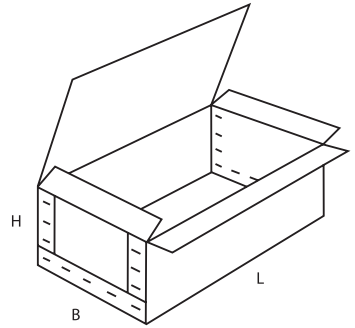
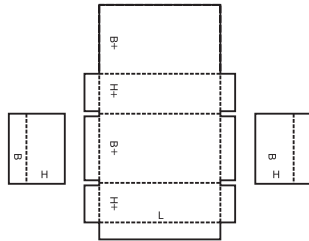

0602

A

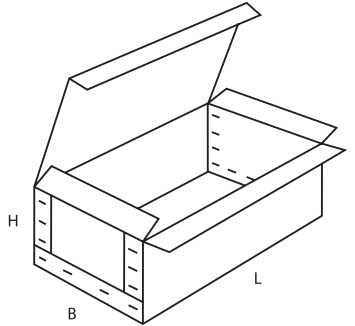
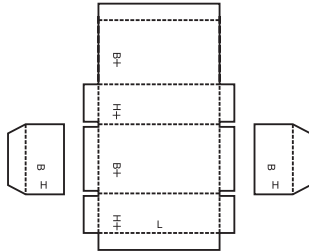

0605

A

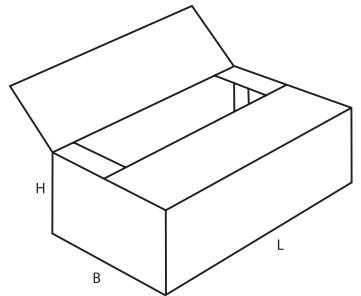
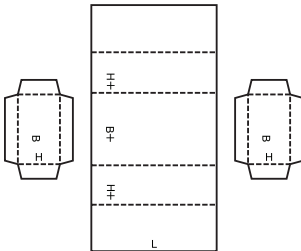

0606

A

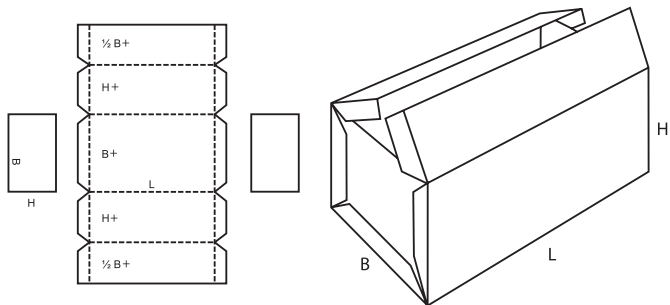

0607

A

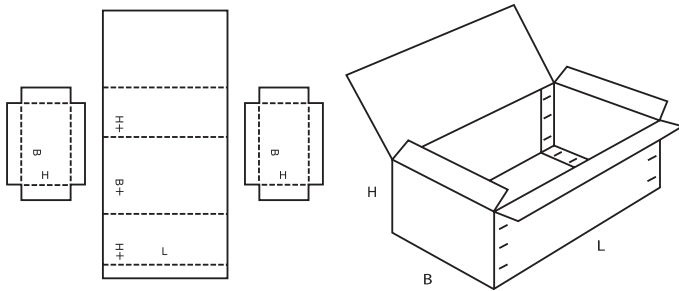

0608

A

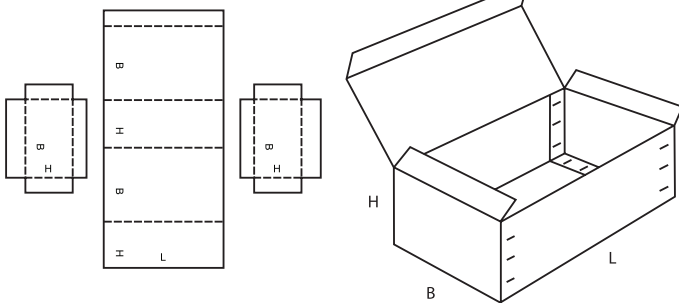

0610

M/A

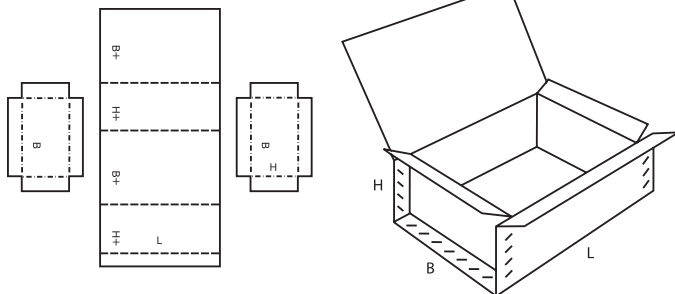

0615

M/A

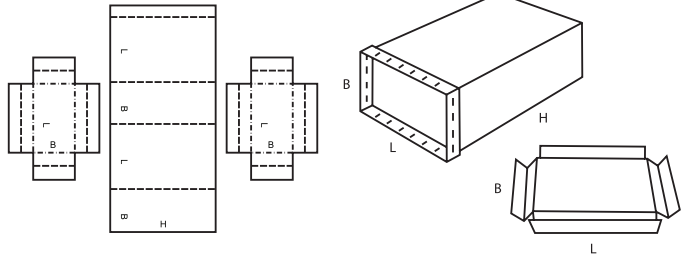

0616

M/A

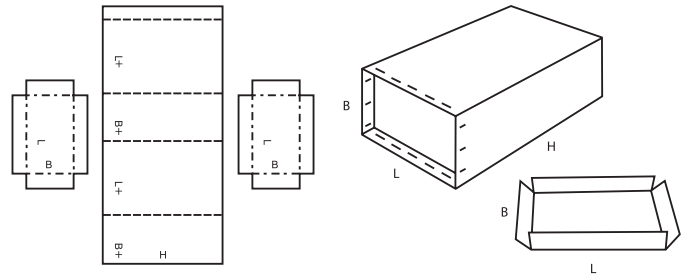

0620

A

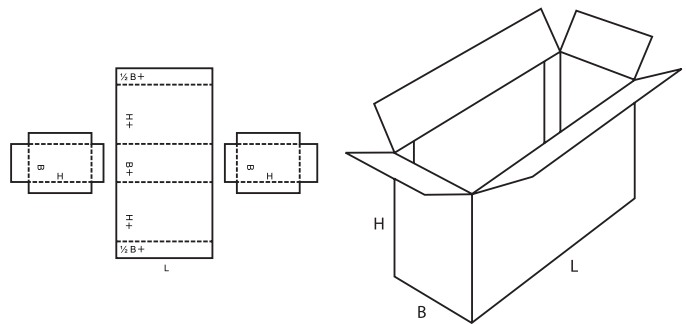

0621

M

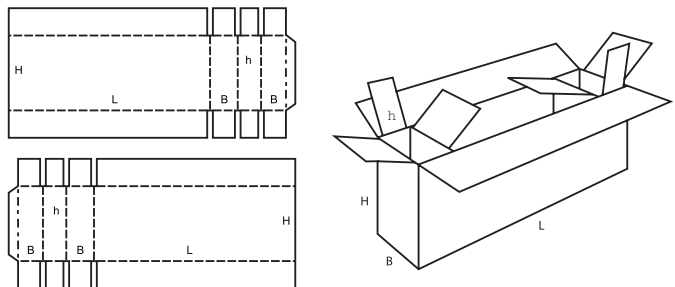

0700

- ▲ **Pudełka klejone jednoczęściowe** są to pudełka klejone, złożone zwykle z jednej części, dostarczane w stanie złożonym i gotowe do użycia po ich prostym rozłożeniu.

0700

M

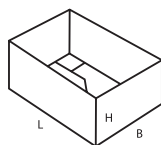
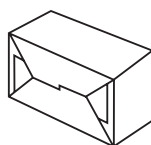
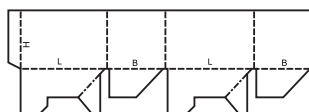

0701

M

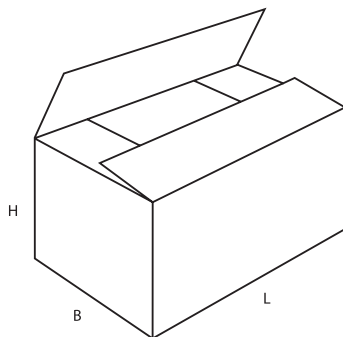
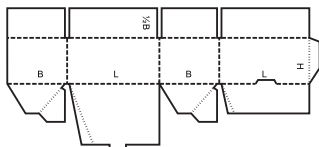

0703

M

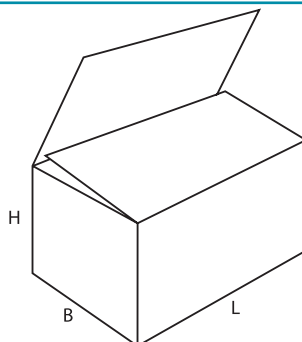
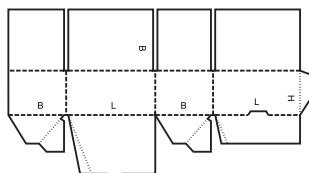

0711

M

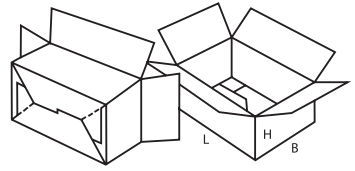
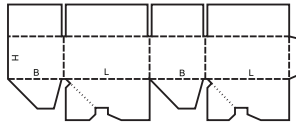

0712

M

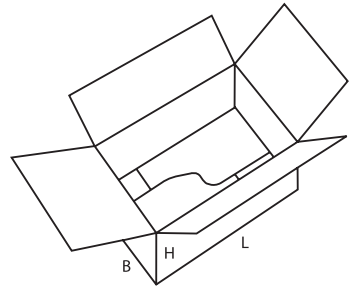
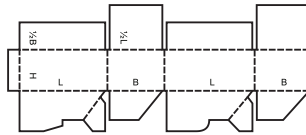

0713

M

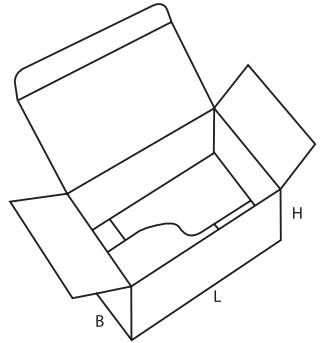
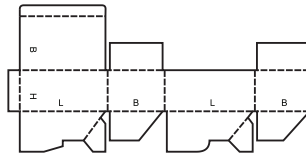

0714

M

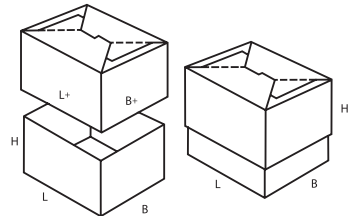
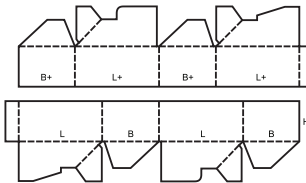

0715

M

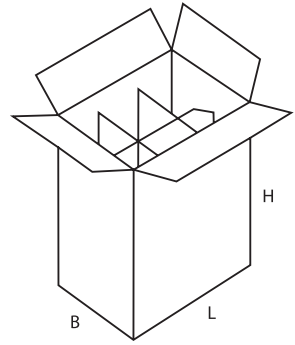
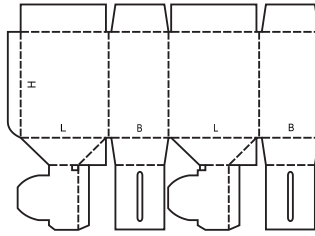

0716

M

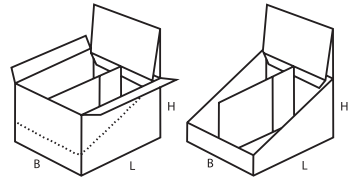
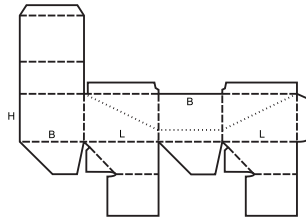

0717

M

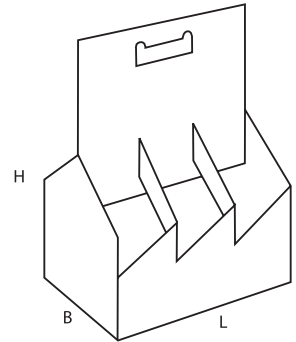
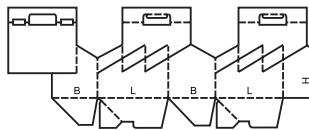

0718

M

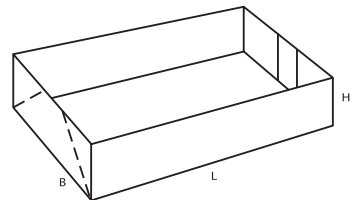
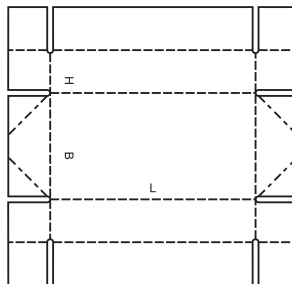

$B \geq 2H$

0747

M

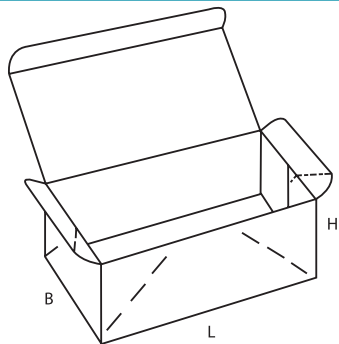
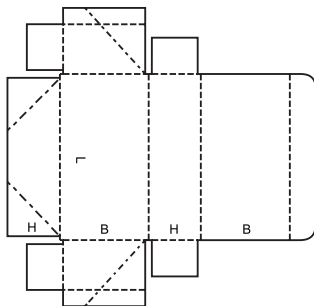

0748

M

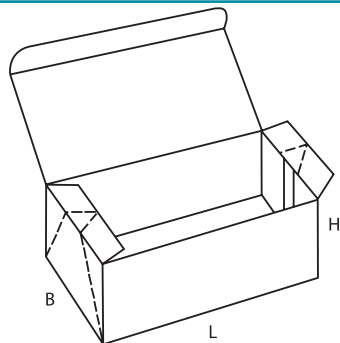
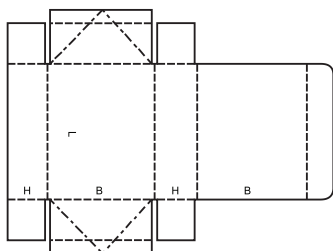

0751

M

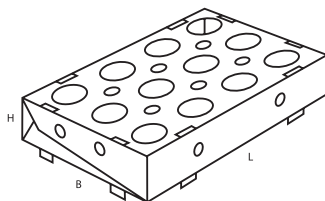
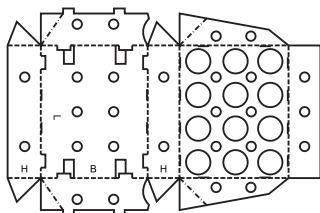

0752

M/A

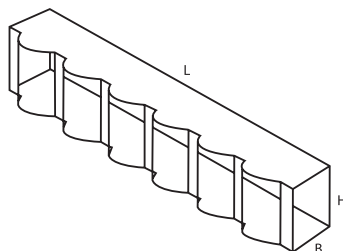
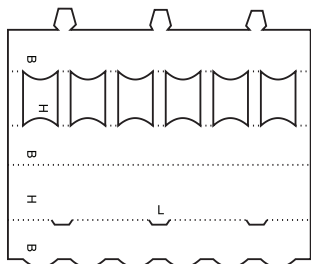

0759

M

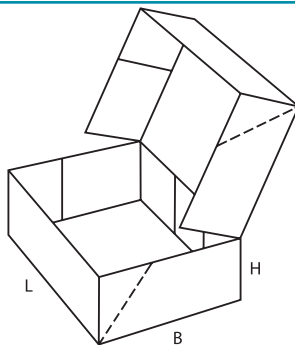
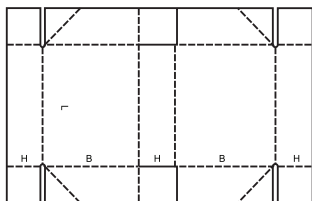

0761

M

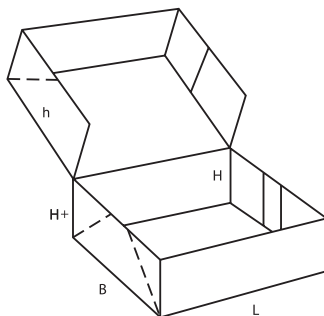
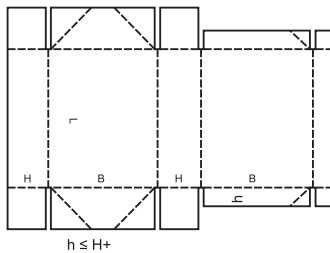

0770

M

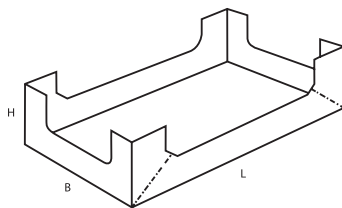
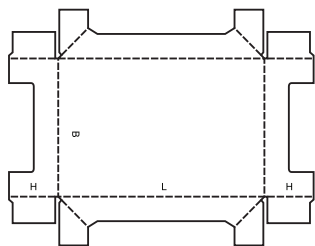

0771

M

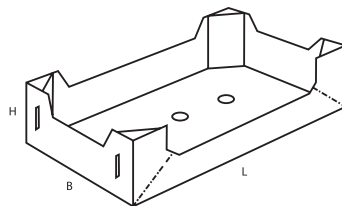
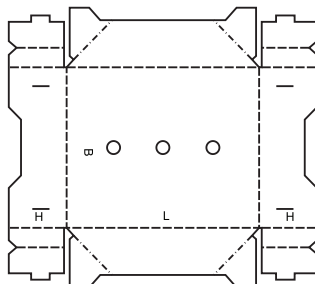

0772

M

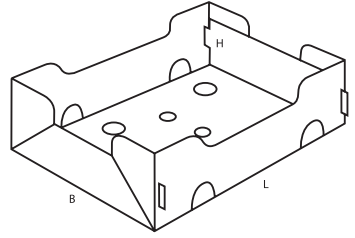
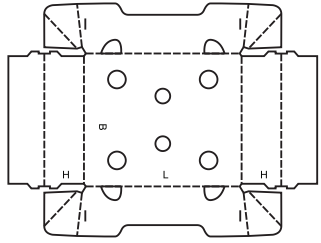

0773

M

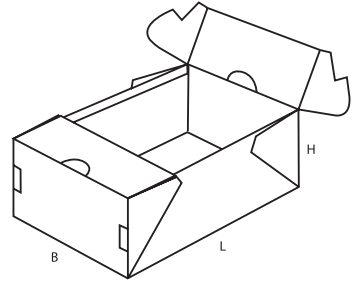
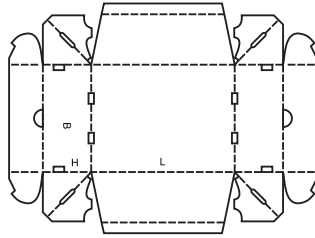

0774

M

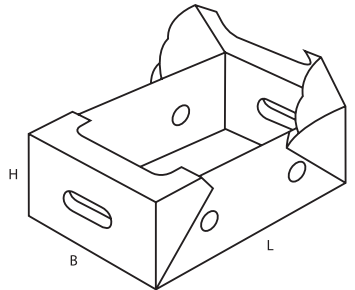
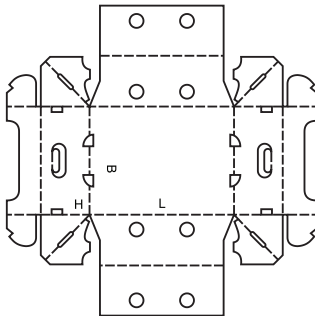

- Wyposażenie wewnętrzne** pudeł, takie jak wkładki, przekładki, kratownice, wkładki wypełniające itd., stanowiące elementy związane z konstrukcją pudła albo osobne. Wskazana ilość elementów jest dowolna i może być, stosownie od wymagań, zwiększana lub zmniejszana.

0900

M

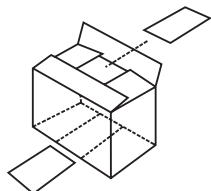

0901

M

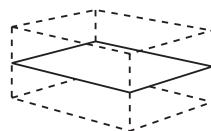

0902

M

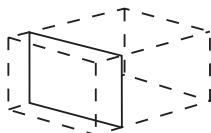

0903

M

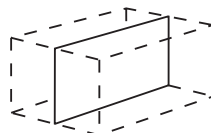
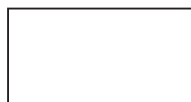

0904

M

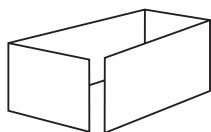

0905

M

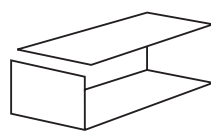
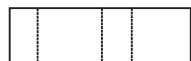

0906

M

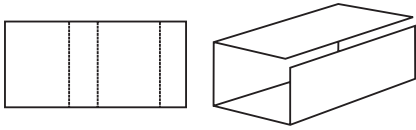

0907

M

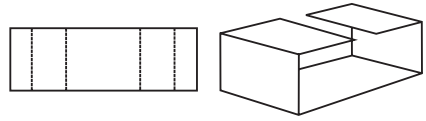

0908

M

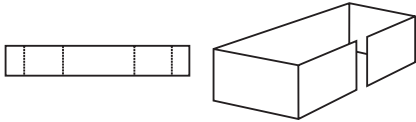

0909

M

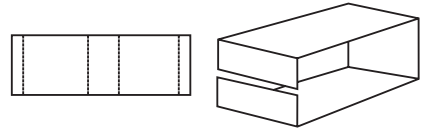

0910

A

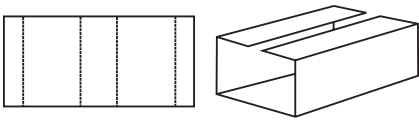

0911

A

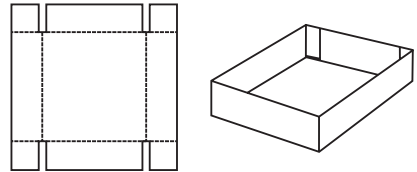

0913

M

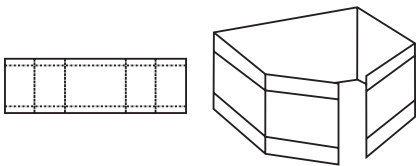

0914

M

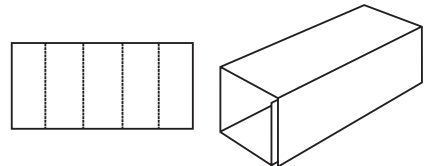

0920

M

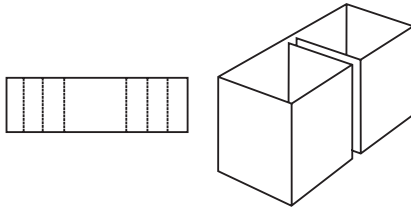

0921

M

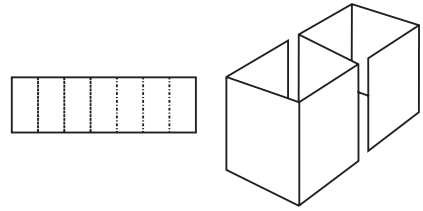

0929

M

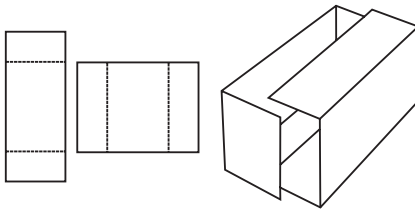

0930

M

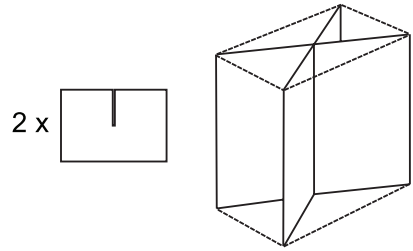

0931

M

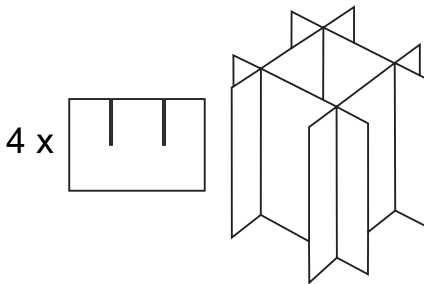

0932

M

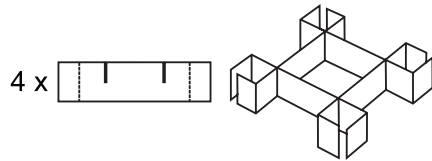

0933

M

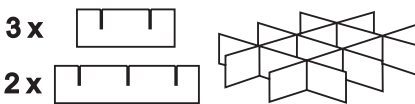

0934

M

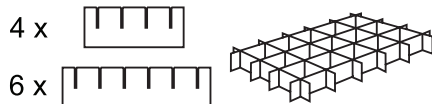

0935

M

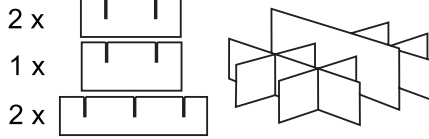

0940

M

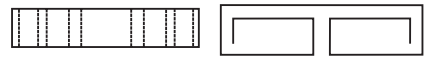

0941

M



0942

M

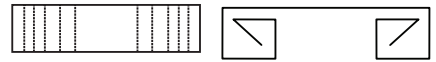

0943

M



0944

M



0945

M



0946

M



0947

M



0948

M



0949

M

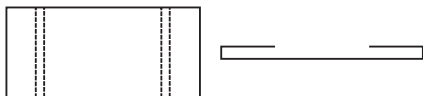

0950

M



0951

M

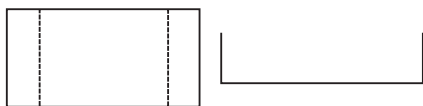

0965

M

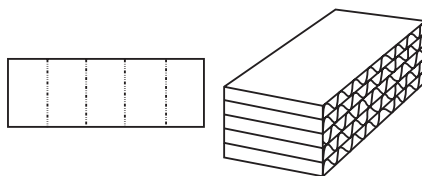

0966

M

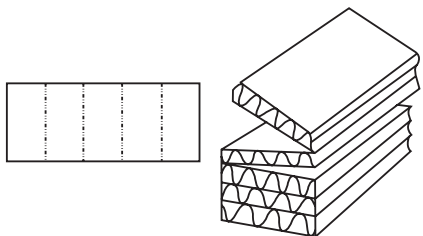

0967

M

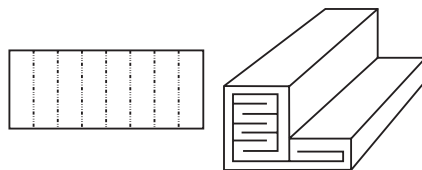

0970

M

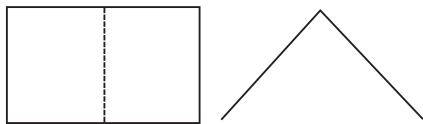

0971

M

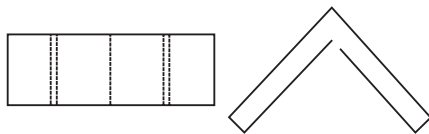

0972

M

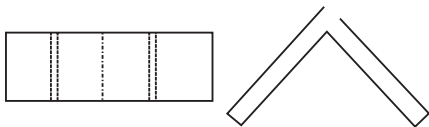

0973

M

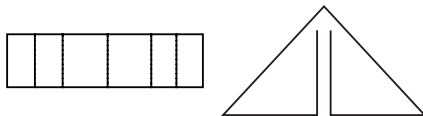

0974

M

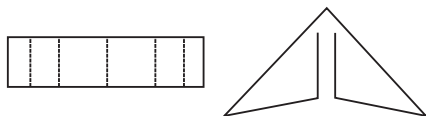

0975

M

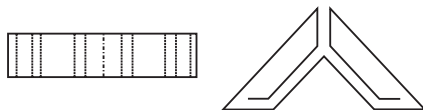

0976

M

